

非汽车件

变更目的	变更内容	修改人	修改日期	客户版本	内部版本
新产品	新规格	陈金珍	2023.6.29	A	A0

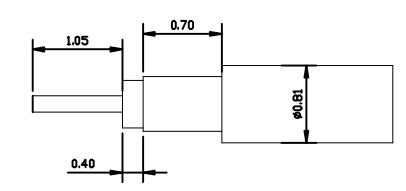
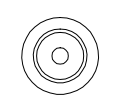
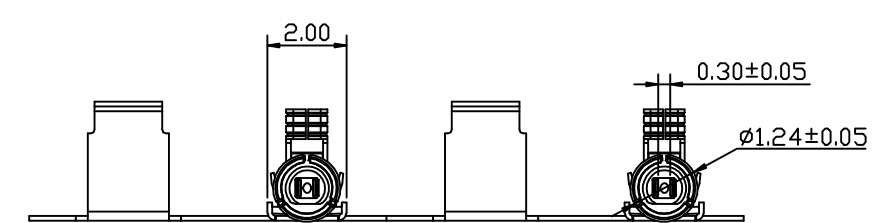
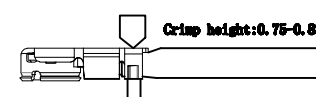
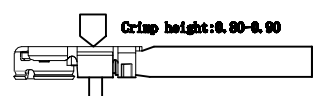
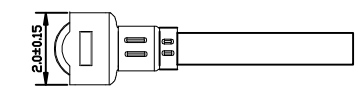
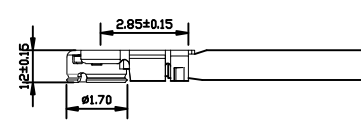
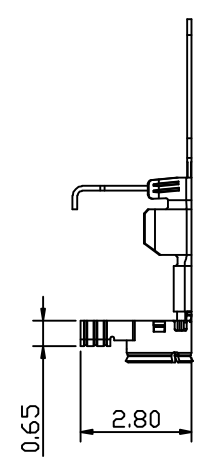
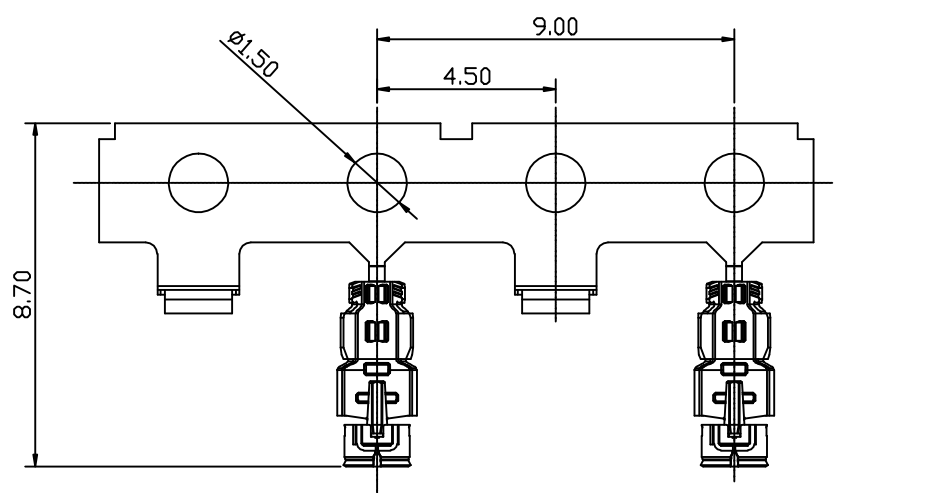
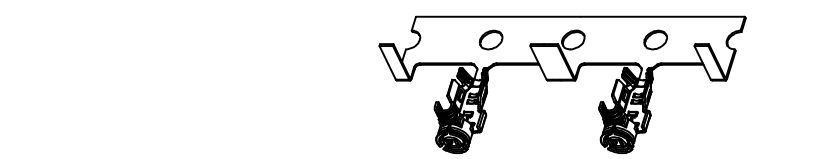

3	SHELL	COPPER ALLOY	GOLD PLATED OVER NI
2	CONTACT	COPPER ALLOY	GOLD PLATED OVER NI
1	HOUSING	PA66	UL94-0
NO	NAME	MATERIAL	DESCRIPTION

UNITS: mm		PART NO.:	昆山康硕电子科技有限公司 Shenzhen KingShan Electronics Technology Co., Ltd.
X.±	X'±	KS-MHF-08/3-N-01	
.X±0.2	.X'±0.1	APPD:	DWG NO.:
.XX±0.10	.XX'±	CHKD:	MHF-08/3-N-01
.XXX±	.XXX'±	DR: Jesen	SCALE SHEET REV. NONE 1/2 A0

非汽车件

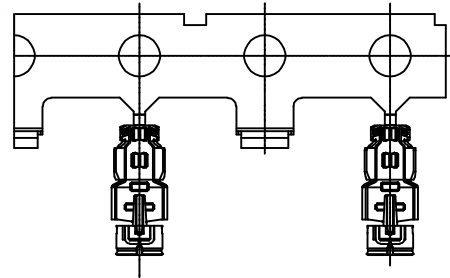

PACKAGE DIRECTION

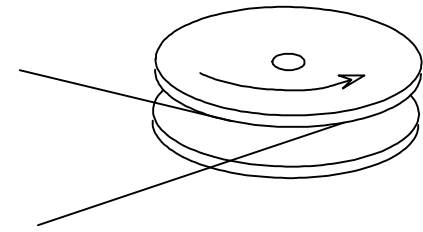

- NOTES -

1. MATERIAL:

- 1-1.HOUSING: THERMOPLASTIC, UL 94V-0, WHITE;
- 1-2.TERMINAL: C5210R-H T=0.1,GOLD FLASH PLATING;
- 1-3.SHELL CARRY: C5210R-H T=0.12, GOLD FLASH PLATING.

2. ELECTRICAL PERFORMANCES:

- 2-1.CONTACT RESISTANCE: 20 mOHMS MAX.;
- 2-3.INSULATION RESISTANCE: 500 MOHMS MIN.;
- 2-4.WITHSTANDING VOLTAGE: 200 V AC FOR 1 MINUTE MIN.;

3. MECHANICAL PERFORMANCES:

- 3-1.DURABILITY:30 CYCLES;
- 3.2 UNMATE FORCE 5N MIN.

4. APPLICABLE CABLE:COAXIAL CABLE 0.81mm.

5.CABLE RETENTION FORCE:0.7Kgf Min

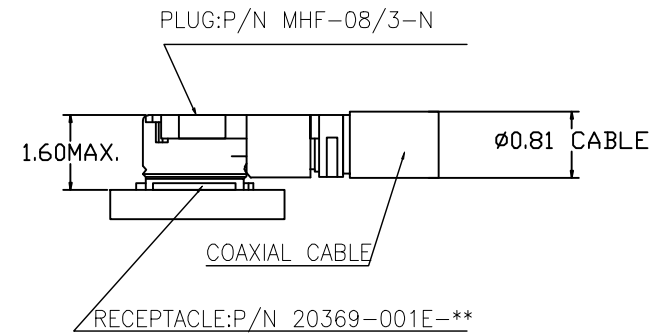

3	SHELL	COPPER ALLOY	GOLD PLATED OVER NI
2	CONTACT	COPPER ALLOY	GOLD PLATED OVER NI
1	HOUSING	PA66	UL94-0
NO	NAME	MATERIAL	DESCRIPTION

UNITS: mm		PART NO.:	昆山尚豪电子科技有限公司 Kunshan Songhao Electronics Technology Co., Ltd.
X.±	X'±	KS-MHF-08/3-N-01	
.XX±0.2	.XX'±0.1	APPD:	DWG NO.:
.XX±0.10	.XX'±	CHKD:	MHF-08/3-N-01
.XXX±	.XXX'±	DR: Jesen	SCALE SHEET REV. NONE 2/2 AO